

PURITY™

Fully Powered Hybrid Electrostatic Loudspeaker

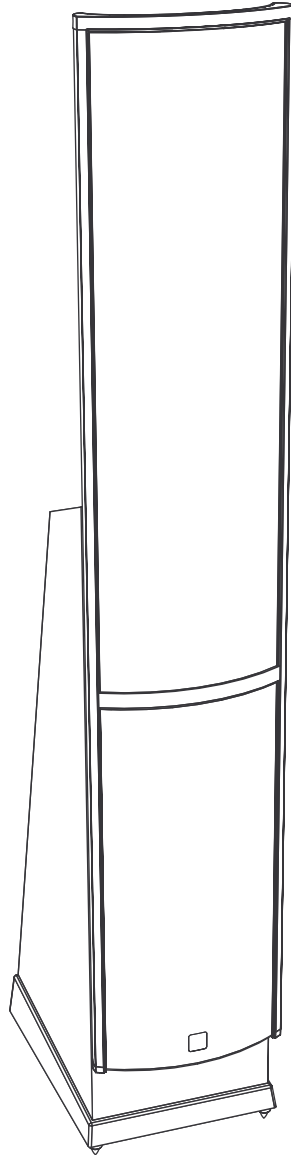

u s e r ' s m a n u a l

Thank you—to you the MartinLogan owner,
for loving what we do,
and
for making it possible for us to do what we love.



Serial Numbers: _____ / _____
Record your serial numbers here for easy reference. You will need this information when filling out your warranty registration. Purity's serial number is located near the bottom of the backplate and on the shipping container. Each individual unit has a unique serial number.

This device complies with part 15 of the FCC Rules. Operation is subject to the following two conditions: (1) This device may not cause harmful interference, and (2) this device must accept any interference received, including interference that may cause undesired operation.

| | |
|---|-----------|
| Contents | 3 |
| Installation in Brief | 4 |
| Introduction | 5 |
| Connections & Controls | 6 |
| AC Power Connection | |
| Status Light | |
| Line Level (RCA) Connection | |
| Speaker Level Connection | 7 |
| Bass Level Control | |
| Break-In | |
| Placement & Room Acoustics | 8 |
| Listening Position | |
| The Wall Behind the Listener | |
| The Wall Behind the Speakers | |
| The Side Walls | |
| Experimentation | |
| Final Placement | 9 |
| The Extra "Tweak" | 10 |
| Your Room | |
| Terminology | |
| Rules of Thumb | 11 |
| Dipolar Speakers and Your Room | |
| Solid Footing | |
| Dispersion Interactions | 12 |
| Controlled Horizontal Dispersion | |
| Controlled Vertical Dispersion | |
| Three Major Types of Dispersion | |
| Home Theater | 13 |
| Electrostatic Advantages | 14 |
| MartinLogan Exclusives | 15 |
| Full Range Operation | |
| CLST™ (Curvilinear Line Source) | 16 |
| Generation 2 Diaphragm | |
| MicroPerf Stator | |

| | |
|--|-----------|
| Vacuum Bonding | |
| AirFrame™ Technology | |
| Electrostatic Loudspeaker History | 17 |
| Frequently Asked Questions | 19 |
| Troubleshooting | 21 |
| General Information | 22 |
| Specifications | |
| Warranty and Registration | |
| Serial Number | |
| Service | |
| Dimensional Drawings | 23 |
| Glossary of Audio Terms | 24 |
| Notes | 26 |



In accordance with the European Union WEEE (Waste Electrical and Electronic Equipment) directive effective August 13, 2005, we would like to notify you that this product may contain regulated materials which upon disposal, according to the WEEE directive, require special reuse and recycling processing.

For this reason MartinLogan has arranged with our distributors in European Union member nations to collect and recycle this product at no cost to you. To find your local distributor please contact the dealer from whom you purchased this product, email info@martinlogan.com or visit the distributor locator at www.martinlogan.com.

Please note, only this product itself falls under the WEEE directive. When disposing of packaging and other related shipping materials we encourage you to recycle these items through the normal channels.



The lightning bolt flash with arrowhead symbol, within an equilateral triangle, is intended to alert the user to the presence of uninsulated "dangerous voltage" within the product's enclosure that may be of sufficient magnitude to constitute a risk of electric shock.



The exclamation point within an equilateral triangle is intended to alert the user to the presence of important operating and maintenance (servicing) instructions in the literature accompanying the appliance.



WARNING! Do not use your Purity loudspeakers outside of the country of original sale—voltage requirements vary by country. Improper voltage can cause damage that will be potentially expensive to repair. The Purity is shipped to authorized MartinLogan distributors with the correct power supply for use in the country of intended sale. A list of authorized distributors can be accessed at www.martinlogan.com or by emailing info@martinlogan.com.

INSTALLATION IN BRIEF

We know you are eager to hear your Purity speakers, so this section is provided to allow fast and easy set up. Once you have them operational, please take the time to read, in depth, the rest of the information in this manual. It will give you perspective on how to attain the greatest possible performance from this most exacting transducer.

If you should experience any difficulties in the setup or operation of your Purity speakers, please refer to the Room Acoustics, Placement or Operation sections of this manual. Should you encounter a persistent problem that cannot be resolved, please contact your authorized MartinLogan dealer. They will provide you with the appropriate technical analysis to alleviate the situation.



WARNING!

- Hazardous voltages exist inside—do not remove cover.
- Refer servicing to a qualified technician.
- To prevent fire or shock hazard, do not expose this module to moisture.
- Turn amplifier off and unplug speaker should any abnormal conditions occur.
- Turn amplifier off before making or breaking any signal connections!
- Do not operate if there is any visual damage to the electrostatic panel element.
- Do not drive speaker beyond its rated power.
- The power cord should not be installed, removed, or left detached from the speaker while the other end is connected to an AC power source.
- No candles or other sources of open flame should be placed on the speaker.
- No liquids either in glasses or vases should be placed on speaker.
- Speaker should not be exposed to dripping or splashing liquids.
- The terminals marked with the lightning bolt symbol should be connected by an instructed person or by way of ready made terminals.
- The power cord should remain readily operable should any abnormal conditions occur.

Step 1: Unpacking

Remove your new Purity speakers from their packaging.

Step 2: Placement

Place each Purity at least two feet from the back wall and angle them slightly toward your listening area. This is a good place to start. Please see the Placement section (pages 8–11) of this manual for more details.

Step 3: Power Connection (AC) *(see warning)*

Your Purity speakers require AC power to energize their electrostatic cells and internal amplifiers. Using the AC power cords provided, plug them in first to the AC power receptacle on the rear panel of the speaker, making sure that you have made a firm connection, and then to a wall outlet. Please see AC Power Connection (pages 6) for more details.

Step 4: Signal Connection

Attach your speakers using either the Line Level input or the Speaker Level input on the rear panel of your speakers.

Use the best cable(s) you can. Higher quality cables, available from your specialty dealer, are recommended and will give you superior performance.

When using the Speaker Level inputs be consistent when connecting speaker leads to the terminals on the back of the Purity speakers. Take great care to assign the same color to the (+) terminal on both the left and right channels. If bass is nonexistent and you cannot discern a tight, coherent image, you may need to reverse the (+) and (–) leads on one side to bring the system into proper polarity. Spade connectors are suggested for optimum contact and ease of installation.

For detailed setup instructions, please turn to the Connections and Controls section (Page 6–7) of this manual for more details.

Step 5: Listen and Enjoy

Now, you may turn on your system and enjoy!

Congratulations! You have invested in one of the world's premier loudspeaker systems.

Internally powered with a high-resolution digital amplifier, the Purity provides an unprecedented level of system connection flexibility. Equipped with a standard line-level input, the Purity is able to connect directly to devices such as digital music players, flat screen televisions or even computers. Additional speaker level inputs also allow Purity to exist in a more traditional receiver or pre-amp equipped 2-channel or home theater system.

The MartinLogan Purity represents an advanced combination of sonic technologies establishing an unprecedented direction for audiophile design. The result of years of research, the new Purity hybrid electrostatic loudspeaker delivers new standards for efficiency, dynamics and precision in a floorstanding loudspeaker.

Housed within a radical, ultra-rigid extruded aluminum AirFrame™, the Purity's CLS transducer builds upon the legacy of MartinLogan's electrostatic heritage with the incorporation of advanced vacuum bonding and MicroPerf stat panels, providing even greater efficiency and precision. The integration electrical interface technology developed by MartinLogan's Statement™ e2 engineering team extends effortless dynamics and purity, resulting in even higher sonic standards of efficiency and precision.

Featuring an advanced crossover topology, MartinLogan carefully builds each Purity crossover utilizing precision audiophile-grade components to preserve sonic subtleties while effortlessly handling the broadest range of dynamics contained within even the most demanding sonic source.

The materials in your new Purity speakers are of the highest quality and will provide years of enduring enjoyment and deepening respect. The cabinetry is constructed from the highest quality composite material for acoustical integrity.

Through rigorous testing, the curvilinear electrostatic panel has proven itself to be one of the most durable and reliable transducers available today. Fabricated from a custom tool punched high-grade steel, the patented panel is then coated with a special polymer that is applied via a proprietary electrostatic bonding process. This panel assembly houses a membrane just 0.0005 of an inch thick.

The other sections of your User's Manual explain in detail the operation of your Purity speakers and the philosophy applied to their design. A clear understanding of your speakers will insure that you obtain maximum performance and pleasure from this most exacting transducer. It has been designed and constructed to give you years of trouble-free listening enjoyment.

CONNECTIONS & CONTROLS

AC Power Connection

Because your Purity speakers use an internal power supply to energize their electrostatic cells and to power the internal amplifiers, they must be connected to an AC power source. For this reason they are provided with the proper IEC standard power cords. These cords should be firmly inserted into the AC power receptacles on the rear connection panel of the speakers, then to any convenient AC wall outlet (see figure 2 & 3). The Purity's integrate a signal sensing power supply which will switch off after five minutes of no music signal, and requires less than two seconds to recharge the panels when a music signal is present.

Your Purity speakers are wired for the power service supplied in the country of original consumer sale. The AC power requirements applicable to a particular unit is specified both on the packing carton and on the serial number plate attached to the speaker. If you remove your Purity speakers from the country of original sale, be certain that the AC power supplied in any subsequent location is suitable before connecting and operating the speakers. Substantially impaired performance or severe damage may occur to an Purity speaker if operation is attempted from an incorrect AC power source.



WARNING! The power cord should not be installed, removed, or left detached from the speaker while the other end is connected to an AC power source.

Status Light

Behind and near the bottom of the stat panel is a status light. This light notates the following operation modes:

- **Blue:** The speaker is active and ready to play.
- **Red:** The speaker is in auto standby mode.
- **Flashing Red:** The speaker is in auto-protect mode. This may occur if the internal amplifier overheats. To reset the speaker unplug it for 10 seconds. *This also occurs if the speaker is being used with an incompatible AC voltage (i.e. outside country of original sale).*
- **Short Red Flash:** This will occur when the speaker is plugged into or unplugged from an AC power source.

Line Level (RCA) Connection

When using the Line Level connection do not use the Speaker Level connections at the same time.

Use Purity's line level connection to attach any of the following devices (see figure 1):

- Television
- Computer
- Digital Music Player or docking station
- Receiver / Pre-Amp (using pre-amp outputs)

Connection is achieved by connecting an RCA cable from the output on the device to the Line level input on the Purity. If your output device is not equipped with an RCA style output connector we recommend using a 3.5mm stereo headphone to dual RCA connector (available at nearly any electronics retailer).

When using Purity's Line Level Input, make sure that the output device's connection utilizes a variable level control (i.e.

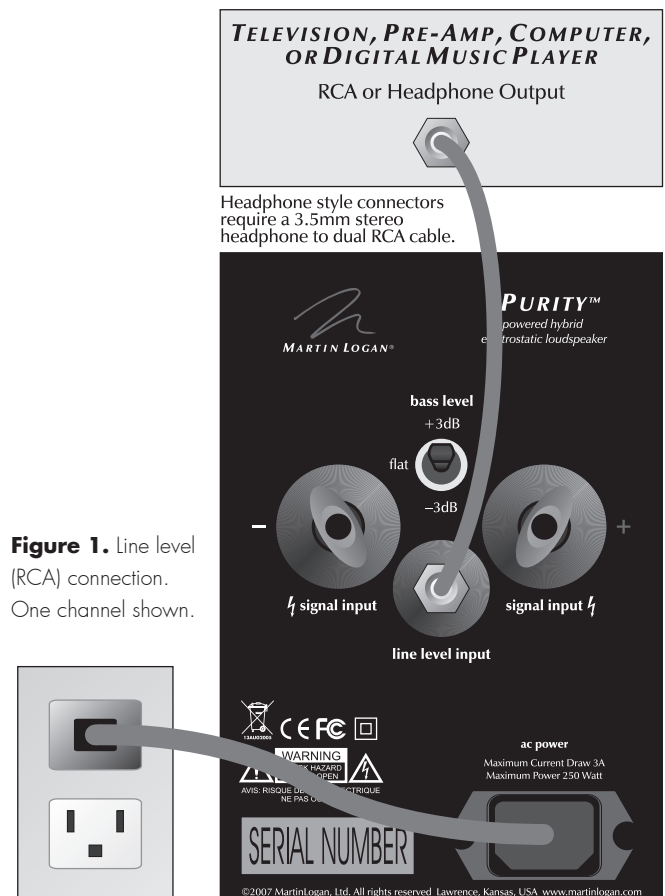

Figure 1. Line level (RCA) connection. One channel shown.

volume control). Usually this is a headphone or pre-amp output. However, as this varies from device to device we recommend referencing your device's user manual.

Please note: When making or breaking connections from devices that utilize the Line Level input a popping noise may occur. This is caused by grounding and static discharge interaction. It is normal and to be expected when using this method of connection. If a cable is connected to the speaker, but is left unterminated at the device end you may also experience a low-level hum. To minimize these intermittent noises we recommend using a device that is permanently connected (such as a digital music player docking station).

Speaker Level Connection

When using the Speaker Level connections do not use the at the Line Level connection same time.

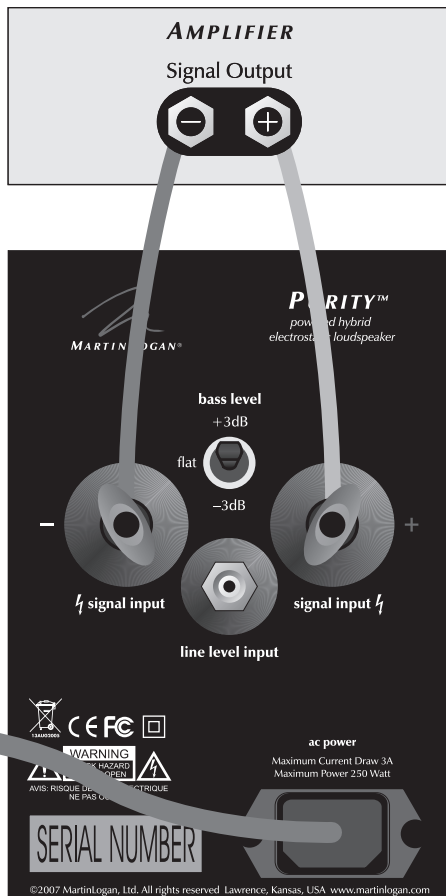

Figure 2. Speaker level connection. One channel shown.

Use spade connectors for optimum contact and ease of installation. Hand tighten the binding posts, but do not overtighten—do not use a tool to tighten the binding posts (see figure 2).

Be consistent when connecting the speaker cables to the signal input terminals. Take care to assign the same color cable lead to the (+) terminal on both the left and right channel speakers. If bass is nonexistent and you cannot discern a tight, coherent image, you may need to reverse the (+) and (-) leads on one speaker to bring the system into proper polarity.

Please note: When using the speaker level inputs a popping noise may occur when the amplifier is turned on or off. This is caused by grounding interaction between the speaker and the amplifier. It is normal and to be expected. The Purity features a built in muting circuit that will detect such anomalies and minimize them.



WARNING! Turn your amplifier off before making or breaking any signal connections!

Bass Level Control

On the rear panel of the Purity electronics module is a three position Bass Level switch that allows you to select the type of low frequency response you desire.

The flat position is considered the normal setting for most rooms. However, if you feel that the bass in your system is too light or heavy relative to the mid and high frequencies, simply select the +3dB or -3dB position to adjust the woofer output.

Some experimentation with these switch settings will allow you to find the optimal tonal balance for your specific taste, room and equipment.

Break-In

When you begin to play your speakers, they will sound a bit bass shy. This is due to the high quality, long-life components used in our woofers. Our custom made, butyl surround woofer requires approximately 72 hours of break-in at 90 dB (moderate listening levels) before any critical listening. The break-in requirements of the crossover components and the electrostatic stator are equivalent.

PLACEMENT & ROOM ACOUSTICS

Listening Position

Your speakers should be placed approximately two to three feet from the front wall, the wall in front of the listening position, and about two feet from the side walls. Your sitting distance should be further than the distance between the speakers themselves. You are trying to attain the impression of good center imaging and stage width.

There is no exact distance between speakers and listener, but there is a relationship. In long rooms, naturally, that relationship changes. The distance between the speakers will be far less than the distance from you to the speaker system. However, in a wide room, you will still find that if the distance from the listener to the speakers becomes smaller than the distance between the speakers themselves, the image will no longer focus in the center.

Now that you have positioned your speaker system, spend time listening. Wait to make any major changes in your initial setup for the next few days as the speaker system itself will change subtly in its sound. Over the first 72 hours of play the actual tonal quality will change slightly with deeper bass and more spacious highs resulting. After a few days of listening you can begin to make refinements and hear the differences.

The Wall Behind the Listener

Near-field reflections can also occur from your back wall (the wall behind the listening position). If your listening position is close to the back wall, these reflections can cause problems and confuse imaging quality. It is better for the wall behind you to be absorptive than to be reflective. If you have a hard back wall and your listening position is close to it, experiment with devices that will absorb information (i.e. wall hangings and possibly even sound absorbing panels).

The Wall Behind the Speakers

The front surface, the wall behind the speakers, should not be extremely hard or soft. A pane of glass will cause reflections, brightness and confused imaging. Curtains, drapery and objects such as bookshelves can be placed along the wall to diffuse an overly reflective surface. A standard sheet rock or textured wall is generally an adequate surface if the rest of the room is not too bright and hard. Walls can also be too soft. If the entire front wall consists of heavy drapery, your system can sound dull. You may hear muted music with little ambience. Harder surfaces will actually help in this case.

The front surface ideally should be one long wall without any doors or openings. If you have openings, the reflection and bass characteristics from each channel can be different.

The Side Walls

A good rule of thumb is to have the side walls as far away from the speaker sides as possible. However, MartinLogan's unique controlled dispersion electrostatic transducer inherently minimizes side wall reflections—a position as little as two feet from the side walls often proves adequate. Sometimes, if the system is bright or the imaging is not to your liking, and the side walls are very near, try putting curtains or softening material directly to the edge of each speaker. An ideal side wall, however, is no side wall at all.

Experimentation

Toe-in

Now you can begin to experiment. First begin by toeing your speakers in towards the listening area and then facing them straight into the room. You will notice the tonal balance and imaging changing. You will notice that as the speakers are toed-out, the system becomes slightly brighter than when toed-in. This design gives you the flexibility to compensate for a soft or bright room.

Generally it is found that the ideal listening position is with the speakers slightly toed-in so that you are listening to the inner third of the curved transducer section. A simple, yet effective method to achieve proper toe involves sitting at the listening position, holding a flashlight under your chin and pointing it at each speaker. The reflection of the flashlight should be within the inner third of the panel (see figure 3).

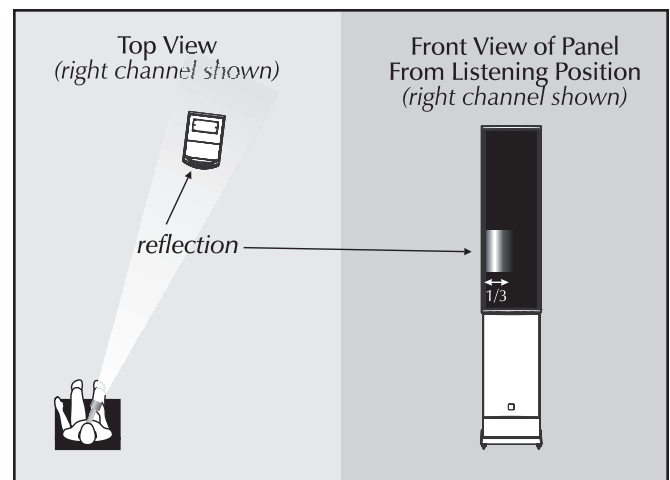
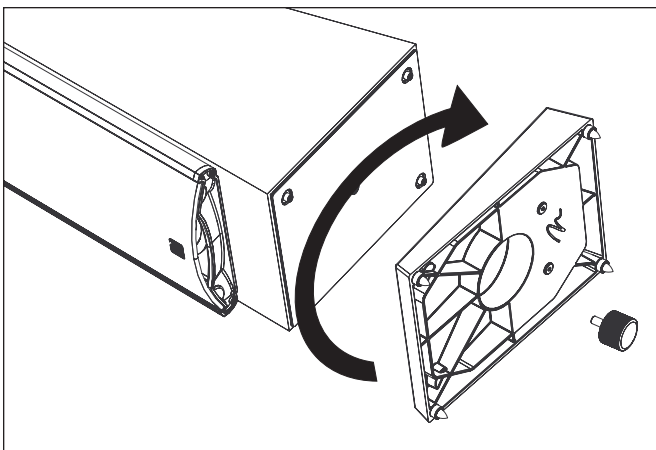
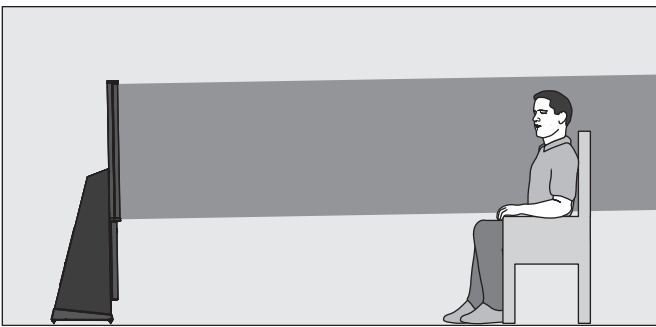
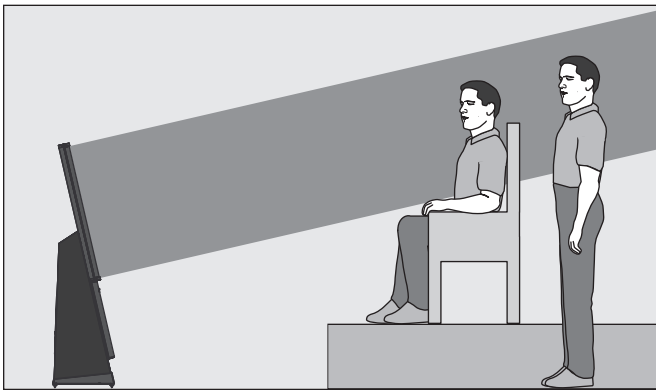

Figure 3. Flashlight toe-in technique.

Tilting the Speakers Backwards and Forwards

As the diagrams show in the Dispersion Interactions section of this manual (page 12), the vertical dispersion is directional above and below the stator panel itself. In some instances, if you are sitting close to the floor, slight forward tilting of the speakers can enhance clarity and precision. Tilt can be adjusted by adjusting the MiniETC spikes (see page 11).

Your Purity loudspeaker also is equipped with a pivoting base which allows the speaker to achieve an additional



Figures 4–6. Rotate the base to accommodate various listening positions.

12° of tilt beyond the standard 1°. Experimenting with increased tilt may yield a superior listening experience.

- 1 Turn off your amplifier. Unplug the speakers and disconnect all wires from the back of the Purity.
- 2 Using a blanket to protect Purity's cabinet, place the speaker on its side.
- 3 Loosen and remove the hand nut on bottom of the speaker.
- 4 Remove the base, rotate it, and replace it.
- 5 Re-attach the hand nut.

Imaging

In their final location, your Purity's can have a stage width somewhat wider than the speakers themselves. On well recorded music, the instruments can extend beyond the edges of each speaker (left and right), yet a vocalist should appear directly in the middle. The size of the instruments should be neither too large nor too small, subject to the intent and results of each unique audio recording.

Additionally, you should find good clues as to stage depth. Make sure that the vertical alignment, distance from the front wall, and toe-in is exactly the same for both speakers. This will greatly enhance the quality of your imaging.

Bass Response

Your bass response should neither be one note nor should it be too heavy. It should extend to the deepest organ passages and yet be tight and well defined. Kick-drums should be tight and percussive—string bass notes should be uniform and consistent throughout the entirety of the run without booming or thudding.

Tonal Balance

Voices should be natural and full and cymbals should be detailed and articulate yet not bright and piercing, pianos should have a nice transient characteristic and deep tonal registers. This will give you clues on how to get closer to these ideal virtues.

Final Placement

After the full break in period, obtaining good wall treatments, and the proper toe-in angle, begin to experiment with the distance from the wall behind the speakers. Move

your speaker slightly forward into the room. What happened to the bass response? What happened to the imaging? If the imaging is more open and spacious and the bass response is tightened, that is a superior position. Move the speakers back six inches from the initial setup position and again listen to the imaging and bass response. There will be a position where you will have pinpoint imaging and good bass response. That position is the point of the optimal placement from the front wall.

Now experiment with placing the speakers farther apart. As the speakers are positioned farther apart, listen again, not so much for bass response but for stage width and good pinpoint focusing. Your ideal listening position and speaker position will be determined by:

- Tightness and extension of bass response
- Width of the stage
- Pinpoint focusing of imaging

Once you have determined the best of all three of these considerations, you will have your best speaker location.

The Extra “Tweak”

This extra “tweak” may be useful when your speakers are placed in a dedicated listening room. Use the following procedure and measurements for your speakers placement to see what can happen to your system’s performance. These formulas will help determine optimum placement of your speakers to minimize standing waves.

- 1 Distance from the front wall (in front of the listening position) to the center of the curvilinear transducer: To determine distance from the front wall, measure the ceiling height (inches) and multiply the figure by 0.618 (i.e. ceiling height (inches) \times 0.618 = the distance from the front wall to the center of the curvilinear transducer).
- 2 Distance from the side-walls to the center of the curvilinear transducer: To determine distance from the side walls, measure the width of your room in inches and divide by 18. Next, multiply the quotient by 5 (i.e. room width in inches \div 18 \times 5 = the distance from the side-walls to the center of the curvilinear transducer).

Your Room

This is one of those areas that requires both a little background to understand and some time and experimentation to obtain the best performance from your system. Your room is actually a component and an important part

of your system. It can dramatically add to, or subtract from, a great musical experience.

All sound is composed of waves. Each note has its own wave size, with the lower bass notes literally encompassing from 10’ feet to as much as 40’ feet. Your room participates in this wave experience like a three dimensional pool with waves reflecting and becoming enhanced depending on the size of the room and the types of surfaces in the room. Remember, your audio system can literally generate all of the information required to recreate a musical event in time, space, and tonal balance. Ideally, your room should not contribute to that information. However, every room does contribute to the sound to some degree. Fortunately MartinLogan had designed the Purity to minimize these anomalies

Terminology

Standing Waves

The parallel walls in your room will reinforce certain notes to the point that they will sound louder than the rest of the audio spectrum and cause “one note bass”, “boomy bass” or “bloated bass”. For instance, 100Hz represents a 10 feet wavelength. Your room will reinforce that specific frequency if one of the dominant dimensions is 10 feet. Large objects in the room such as cabinetry or furniture can help to minimize this potential problem. Some serious “audiophiles” will literally build a special room with no parallel walls just to help eliminate this phenomenon.

Reflective Surfaces (near-field reflections)

The hard surfaces of your room, particularly if close to your speaker system, will reflect some waves back into the room over and over again, confusing the clarity and imaging of your system. The smaller sound waves are mostly affected here, and occur in the mid and high frequencies. This is where voice and frequencies as high as the cymbals occur.

Resonant Surfaces and Objects

All of the surfaces and objects in your room are subject to the frequencies generated by your system. Much like an instrument, they will vibrate and “carry on” in syncopation with the music, and contribute in a negative way to the music. Ringing, boominess, and even brightness can occur simply because they are “singing along” with your music.

Resonant Cavities

Small alcoves or closet type areas in your room can be chambers that create their own “standing waves” and can drum their own “one note” sounds. Clap your hands. Can you hear an instant echo respond

back? You have near-field reflections. Stomp your foot. Can you hear a “boom”? You have standing waves or large panel resonances such as a poorly supported wall. Put your head in a small cavity area and talk loudly. Hear a booming? You’ve just experienced a cavity resonance.

Rules of Thumb

Hard vs. Soft Surfaces

If the front or back wall of your listening room is soft, it might benefit you to have a hard or reflective wall in opposition. The ceiling and floor should follow the same basic guideline as well. However, the side walls should be roughly the same in order to deliver a focused image.

This rule suggests that a little reflection is good. As a matter of fact, some rooms can be so “over damped” with carpeting, drapes and sound absorbers that the music system can sound dull and lifeless. On the other hand, rooms can be so hard that the system can sound like a gymnasium with too much reflection and brightness. The point is that balance is the optimum environment.

Breakup Objects

Objects with complex shapes, such as bookshelves, cabinetry and multiple shaped walls can help break up those sonic gremlins and diffuse any dominant frequencies.

Dipolar Speakers and Your Room

MartinLogan electrostatic loudspeakers are known as dipolar radiators. This means that they produce sound from both their fronts and their backs. Consequently, musical information is reflected by the wall behind them and may arrive, either in or out of step, with the information produced by the front of the speaker.

The low frequencies can either be enhanced or nulled by the position from the front wall. Your Purity’s have been designed to be placed two to three feet from the front wall (the wall in front of the listening position) to obtain the best results; however, your room may see things differently. So listening to the difference of the bass response as a result of the changes in distance from the front wall can allow you to get the best combination of depth of bass and tonal balance.

Now that you know about reflective surfaces and resonant objects, you can see how the midrange and high frequencies can be affected. The timing of the initial wave as it radiates to your ears, and then the reflected information as it arrives at your ears later in time, can result in confusion of the precious timing information that carries the clues to imag-

ing. Consequently the result is blurred imaging and excessive brightness. Soft walls, curtains, wall hangings, or sound dampeners (your dealer can give you good information here) can be effective if these negative conditions occur.

Solid Footing

After living and experimenting with your Purity speakers, you may want to use ETC (energy transfer coupler) Spikes (see figure 7), which are available from your local MartinLogan dealer or from the Xtatic shop at www.martinlogan.com. With the use of these spikes, the Purity will become more firmly planted on the floor and, consequently, bass will tighten and imaging will become more coherent and detailed. It is best not to implement the spikes, however, until you are secure in the positioning, as the spikes can damage the floor if the speaker is moved. MartinLogan ETC spikes will fit any common 1/4" x 20 thread insert that may be found on your other audio equipment (racks, etc.)

Spike Installation Instructions:

- 1 Carefully place your speaker on its side.
- 2 Remove existing feet. Thread new spikes into holes and screw them in all of the way. If the speaker does not sit level loosen one spike until level is achieved.
- 3 Tighten the jam nut snugly by hand. Do not over tighten.
- 4 Right the speaker.

Caution: Make sure your hands and any cabling are clear of the spikes. Do not slide speaker as spikes are sharp and can damage your floor or carpet.

- 5 Adjust to level by rotating spikes. Tighten the jam nut securely when satisfied that speaker is level. **Caution:** Walking the speaker may result in a broken spike.

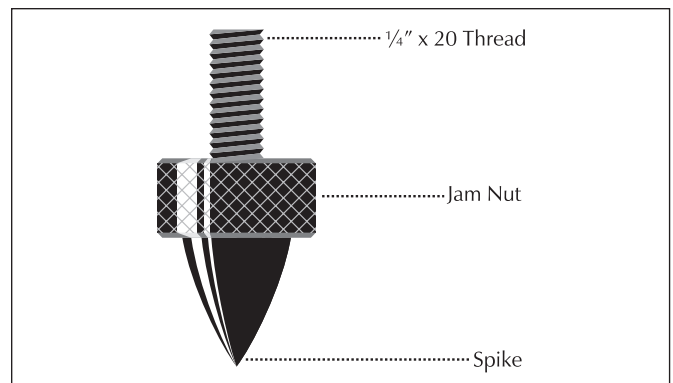

Figure 7. The ETC Spike.

DISPERSION INTERACTIONS

Controlled Horizontal Dispersion

Your Purity's launch a 30 degree horizontal dispersion pattern. This horizontal dispersion field gives a choice of good seats for the performance while minimizing interactions with side walls (see figure 12). Make sure both speakers stand exactly at the same vertical angle, otherwise the image can be skewed or poorly defined. The wave launch of both speakers is extremely accurate in both the time and spectral domain. Consequently, small refined adjustments can result in noticeable sonic improvements.

Controlled Vertical Dispersion

As you can see from the illustrations, your Purity speakers project a controlled dispersion pattern (see figure 13). Each Purity is a 28 inch line source beginning 24 inches above the base. This vertical dispersion profile minimizes interactions with the floor and the ceiling.

Three Major Types of Dispersion

It is a known fact that as the sound wave becomes progressively smaller than the transducer producing it, the dispersion of that wave becomes more and more narrow, or directional. This fact occurs as long as the transducer is a flat surface. Large flat panel speakers exhibit venetian blind effects due to this phenomenon. This is one reason why many manufacturers opt for small drivers (i.e. tweeters and midrange) to approximate what is known as a point source wave launch.

Historically, most attempts to achieve smooth dispersion from large flat panel transducers resulted in trade-offs. After exhaustive testing of many different methods, we conceived an elegantly simple, yet intensely hand crafted process. By curving the radiating surface, we create the effect of a horizontal arc. This allows the engineers at MartinLogan to control the high frequency dispersion pattern of our transducers.

Figure 8-9. As can be seen here, point source concepts invite a great deal of room interaction. While delivering good frequency response to a large listening audience, imaging is consequently confused and blurred.

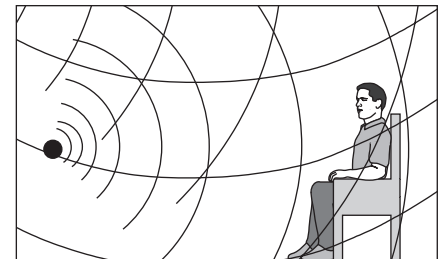
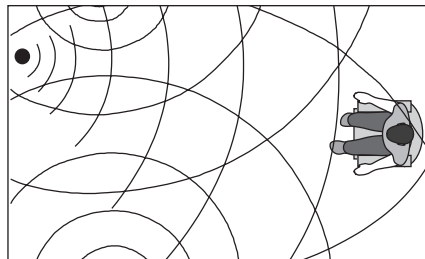

Figure 10-11. Even though they suffer from "venetian blind" effect, angled multiple panel speakers can deliver good imaging, but only to specific spots in the listening area.

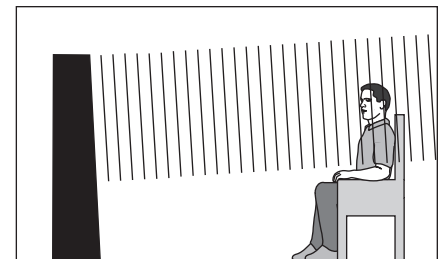
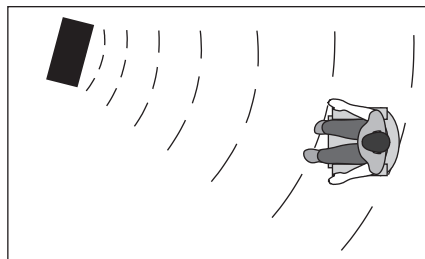
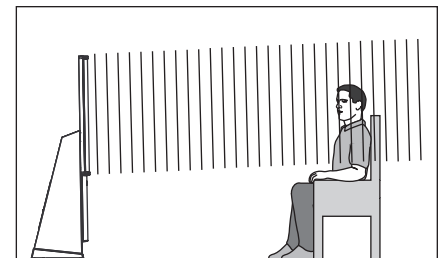
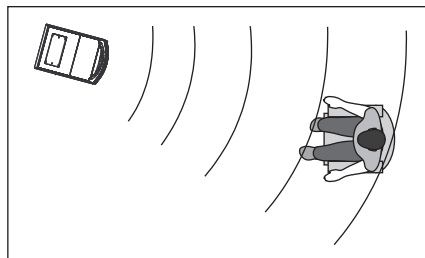

Figure 12-13. A controlled 30 degree cylindrical wave-front, a MartinLogan exclusive, offers optimal sound distribution with minimal room interaction. The result is solid imaging with a wide listening area.



It had long been the practice of stereo buffs to connect their television to a stereo system. The advantage was the use of the larger speakers and more powerful amplifier of the stereo system. Even though the sound was greatly improved, it was still mono and limited by the broadcast signal.

In the late 1970's and early 1980's two new home movie formats became widely available to the public: VCR and laser disc.

By 1985, both formats had developed into very high quality audio/video sources. In fact, the sonic performance of some video formats exceeded audio-only formats. Now, with theater-quality sound available at home, the only element missing was the "surround sound" presentation found in movie houses.

Fortunately, Dolby and DTS encoded DVD's emerged with the same surround sound information encoded on home releases as the theatrical release. Additionally, new high-resolution home-viewing formats such as HD-DVD and Blu-ray as well as high-definition content provided via cable or satellite have evolved which include multi-channel encoded audio that is virtually master tape quality. All that is required to retrieve this information is a decoder and additional speakers and amps to reproduce it.

Home theater is a complex purchase and we recommend that you consult your local MartinLogan dealer, as they are well versed in this subject.

Each piece of a surround system can be purchased separately. Take your time and buy quality. No one has ever complained that the movie was too real. The following list and descriptions will give you only a brief outline of the responsibilities and demands placed on each speaker.

Front Left and Front Right

If these speakers will be the same two used for your stereo playback, they should be of very high quality and able to play loudly (over 102 dB) and reproduce bass below 80 Hz.

Center Channel

This is the most important speaker in a home theater system, as almost all of the dialogue and a large portion of the front speaker information is reproduced by the center channel. It is important that the center speaker be extremely accurate and mate well with the front speaker,

and that it is recommended for use as a center speaker. This is not the place to cut corners.

Surround Speakers

We recommend (along with the film industry) that the surround speakers play down to at least 80 Hz. Surround speakers contain the information that makes it appear that planes are flying over your head. Some may suggest that this is the place to save money and purchase small, inexpensive speakers. If you choose to do so, be prepared to upgrade in the future as discrete multi-channel digital encoding is proliferating rapidly and the demands on surround speakers have increased.

Subwoofer

With any good surround system you will need one or more high-quality subwoofers (the .1 in a 5.1, 6.1, or 7.1 channel surround system). Most movie soundtracks contain large amounts of bass information as part of the special effects. Good subwoofers will provide a foundation for the rest of the system.

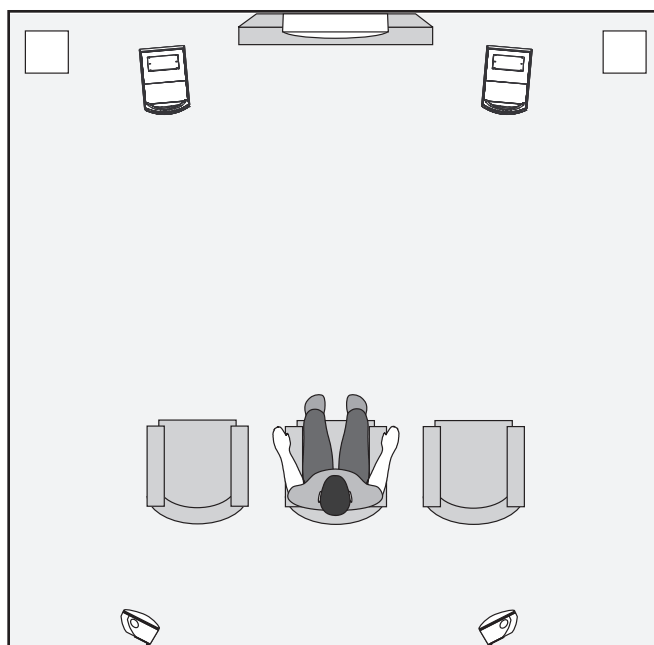

Figure 14. Purity speakers as front channels, Vignette speakers above the television and along the back wall as the center and surround (effects) channels, and Dynamo subwoofers in the front corners as the 0.1 (effects) channel.

ELECTROSTATIC ADVANTAGES

How can sound be reproduced by something that you are able to see through? Electrostatic energy makes this possible.

Where the world of traditional loudspeaker technology deals with cones, domes, diaphragms and ribbons that are moved with magnetism, the world of electrostatic loudspeakers deals with charged electrons attracting and repelling each other.

To fully understand the electrostatic concept, some background information will be helpful. Remember when you learned in a science or physics class that like charges repel each other and opposite charges attract each other? Well, this principle is the foundation of the electrostatic concept.

An electrostatic transducer consists of three pieces: stators, the diaphragm and spacers (see figure 15). The diaphragm is what actually moves to excite the air and create music. The stator's job is to remain stationary, hence the word stator, and to provide a reference point for the moving diaphragm. The spacers provide the diaphragm with a fixed distance in which to move between the stators.

As your amplifier sends music signals to an electrostatic speaker, these signals are changed into two high-voltage signals that are equal in strength but opposite in polarity. These high voltage signals are then applied to the stators. The resulting electrostatic field, created by the opposing high voltage on the stators, works simultaneously with and against the diaphragm, consequently moving it back and forth, producing music. This technique is known as

push-pull operation and is a major contributor to the sonic purity of the electrostatic concept due to its exceptional linearity and low distortion.

Since the diaphragm of an electrostatic speaker is uniformly driven over its entire area, it can be extremely light and flexible. This allows it to be very responsive to transients, thus perfectly tracing the music signal. As a result, great delicacy, nuance and clarity is possible. When you look at the problems of traditional electromagnetic drivers, you can easily see why this is so beneficial. The cones and domes which are used in traditional electromagnetic drivers cannot be driven uniformly because of their design. Cones are driven only at the apex. Domes are driven at their perimeter. As a result, the rest of the cone or dome is just "along for the ride". The very concept of these drivers requires that the cone or dome be perfectly rigid, damped and massless. Unfortunately, these conditions are not available in our world today.

To make these cones and domes move, all electromagnetic drivers must use voice coils wound on formers, spider assemblies, and surrounds to keep the cone or dome in position (see figure 16). These pieces, when combined with the high mass of the cone or dome materials used, make it an extremely complex unit with many weaknesses and potential for failure. These faults contribute to the high distortion products found in these drivers and is a tremendous disadvantage when you are trying to change motion as quickly and as accurately as a loudspeaker must (40,000 times per second!).

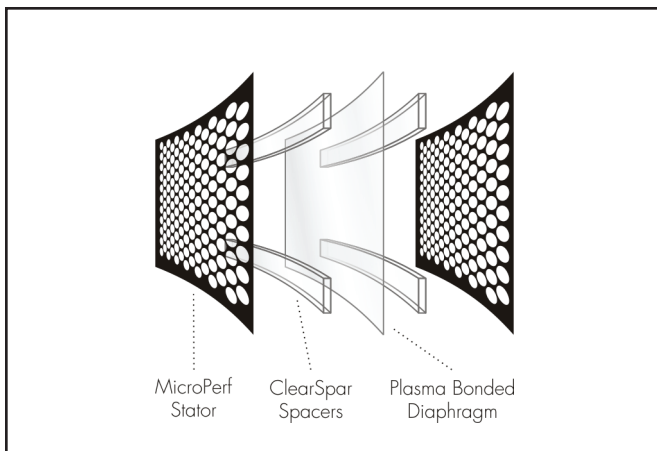

Figure 15. Cut away view of an electrostatic transducer. Notice the simplicity due to minimal parts usage.

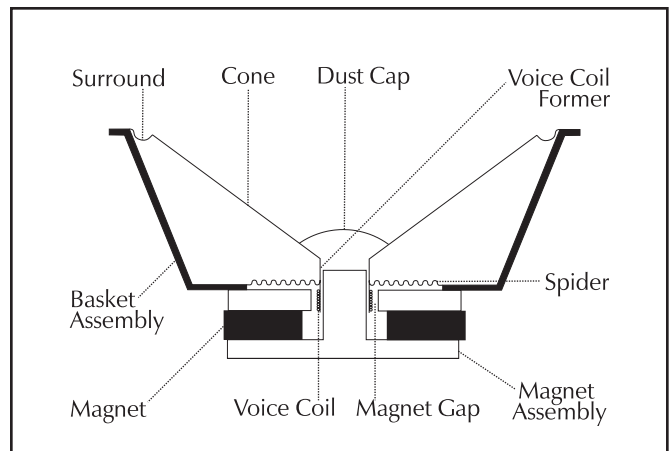

Figure 16. Cut away view of a typical moving coil driver. Notice the complexity due to the high number of parts.

Full Range Operation

Another significant advantage of MartinLogan's exclusive transducer technology reveals itself when you look at examples of other loudspeaker products on the market today.

The Purity uses no crossover networks above 450 Hz because they are not needed. The Purity consists of a single, seamless electrostatic membrane reproducing all frequencies above 450 Hz simultaneously. How is this possible?

First we must understand that music is not composed of separate high, mid and low frequency pieces. In fact, music is comprised of a single complex waveform with all frequencies interacting simultaneously.

The electrostatic transducer of the Purity essentially acts as an exact opposite of the microphones used to record the original event. A microphone, which is a single working element, transforms acoustic energy into an electrical signal that can be amplified or preserved by some type of storage media. The Purity's electrostatic transducer transforms electrical energy from your amplifier back into acoustical energy.

Due to the limitations of electromagnetic drivers, no single unit can reproduce the full range of frequencies. Instead, these drivers must be designed to operate within a nar-

row, fixed bandwidth of the frequency range, and then combined electrically so that the sum of the parts equals the total signal. While nice in theory, we must deal with real-world conditions.

In order to use multiple drivers, a crossover network is enlisted to attempt a division of the complex musical signal into the separate pieces (usually highs, mids, and lows) that each specific driver was designed to handle. Unfortunately, due to the phase relationships that occur within all crossover networks and during the acoustical recombination process, nonlinearities and severe degradation of the music signal take place in the ear's most critical zone (see figure 17).

The Purity's electrostatic transducer can single-handedly reproduce all frequencies above 450 Hz simultaneously. You have in one transducer the ability to handle in elegant simplicity the critical frequencies above 450 Hz.

The crossover phase aberrations that are associated with traditional tweeter, midrange, and woofer systems are eliminated. The result is a dramatic improvement in imaging and staging performance due to the minutely accurate phase relationship of the full-range panel wave launch.

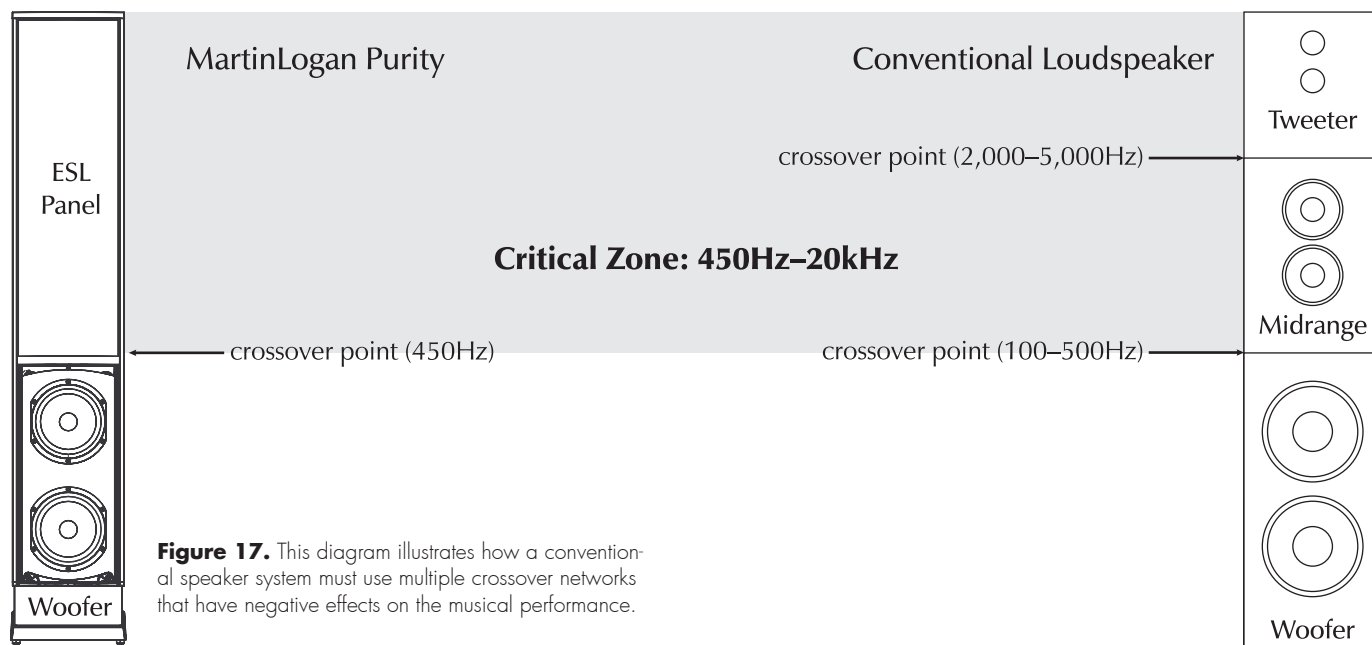

Figure 17. This diagram illustrates how a conventional speaker system must use multiple crossover networks that have negative effects on the musical performance.

CLS™ (Curvilinear Line Source)

Since the beginning of audio, achieving smooth dispersion has been a problem for all designers. Large panel transducers present unique challenge because the larger the panel, the more directional the dispersion pattern becomes.

Wide range electrostats have long been one of the most problematic transducers because they attain their full range capabilities via a large surface area. It looked as if they were in direct conflict to smooth dispersion and almost every attempt to correct this resulted in either poor dispersion or a serious compromise in sound quality.

After extensive research, MartinLogan engineers discovered an elegantly simple solution to achieve a smooth pattern of dispersion without degrading sound quality. By curving the horizontal plane of the electrostatic transducer, a controlled horizontal dispersion pattern could be achieved, yet the purity of the almost massless electrostatic diaphragm remained uncompromised. After creating this technology, MartinLogan developed the production capability to bring it out of the laboratory and into the market place. You will find this proprietary MartinLogan technology used in all of our electrostatic products. It is one of the many reasons behind our reputation for high quality sound with practical usability. This is also why you see the unique “see through” cylindrical shape of MartinLogan products.

Generation 2 Diaphragm

Purity’s diaphragm employs an extremely sophisticated conductive coating applied to the polymer surface at an atomic level using a plasma bonding process. A proprietary compound is driven into the surface of the polymer film in an oxygen free argon chamber. This process allows extremely uniform surface resistivity characteristics, an optically transparent surface, and a nearly massless diaphragm. This uniform surface resistivity controls the electrostatic charge on the diaphragm surface and regulates its migration. As a result, no discharging or “arcing” can occur.

MicroPerf Stator

Sleek. Compact. MicroPerf stator technology, featured in Purity’s electrostatic transducer, reveals more open playable area in each panel, offering increased performance from even more compact stat panels. It is significant to note that the electrostatic transducer in the radical new Purity loudspeaker supports the bandwidth and dynamics associated with traditional electrostatic panels nearly twice its size.

Vacuum Bonding

To achieve the power, precision, and strength of the electrostatic transducer, two insulated high-purity carbon steel stators along with a proprietary plasma bonded diaphragm and ClearSpar™ spacers are fused into a curved geometry with an aerospace adhesive whose strength exceeds that of welding. Our proprietary Vacuum Bonding process guarantees uniform diaphragm tensioning and extremely precise construction tolerances, resulting in unequivocal precision, linearity and efficiency.

AirFrame™ Technology

Ultra-rigid extruded aerospace grade aluminum alloy AirFrame™ technology rigidifies and secures the electrostatic panel to the woofer cabinet while at the same time providing sonic and electrical isolation. Advanced AirFrame™ technology maximizes the electrostatic panels playable surface area and dipole dispersion pattern while minimizing potentially acoustically destructive intermodulated distortion caused by spurious vibrations and resonance. The result? Ultimate imaging capability, low-level detail resolution, improved efficiency and overall accuracy.

In the late 1800's, any loudspeaker was considered exotic. Today, most of us take the wonders of sound reproduction for granted.

It was 1880 before Thomas Edison had invented the first phonograph. This was a horn-loaded diaphragm that was excited by a playback stylus. In 1898, Sir Oliver Lodge invented a cone loudspeaker, which he referred to as a "bellowing telephone", that was very similar to the conventional cone loudspeaker drivers that we know today. However, Lodge had no intention for his device to reproduce music because in 1898 there was no way to amplify an electrical signal! As a result, his speaker had nothing to offer over the acoustical gramophones of the period. It was not until 1906 that Dr. Lee DeForrest invented the triode vacuum tube. Before this, an electrical signal could not be amplified. The loudspeaker, as we know it today, should have ensued then, but it did not. Amazingly, it was almost twenty years before this would occur.

Rice and Kellogg had narrowed the field of "contestants down" to the cone and the electrostat.

In 1921, the electrically cut phonograph record became a reality. This method of recording was far superior to the mechanically cut record and possessed almost 30 dB of dynamic range. The acoustical gramophone couldn't begin to reproduce all of the information on this new disc. As a result, further developments in loudspeakers were needed to cope with this amazing new recording medium.

By 1923, Bell Telephone Laboratories made the decision to develop a complete musical playback system consisting of an electronic phonograph and a loudspeaker to take advantage of the new recording medium. Bell Labs assigned the project to two young engineers, C. W. Rice and E. W. Kellogg.

Rice and Kellogg had a well equipped laboratory at their disposal. This lab possessed a vacuum tube amplifier with an unheard of 200 watts, a large selection of the new electrically cut phonograph records and a variety of loudspeaker prototypes that Bell Labs had been collecting over the past decade. Among these were Lodge's cone, a speaker that used compressed air, a corona discharge (plasma) speaker, and an electrostatic speaker.

After a short time, Rice and Kellogg had narrowed the field of "contestants" down to the cone and the electrostat. The outcome would dictate the way that future generations would refer to loudspeakers as being either "conventional" or "exotic".

Bell Laboratory's electrostat was something to behold. This enormous bipolar speaker was as big as a door. The diaphragm, which was beginning to rot, was made of a pig intestine that was covered with fine gold leaf to conduct the audio signal.

When Rice and Kellogg began playing the new electrically cut records through the electrostat, they were stunned and impressed. The electrostat performed splendidly. They had never heard instrumental timbres reproduced with such realism. This system sounded like real music rather than the honking, squawking rendition of the acoustic gramophone. Immediately, they knew they were on to something big. The acoustic gramophone was destined to become obsolete.

Due to Rice and Kellogg's enthusiasm, they devoted a considerable amount of time researching the electrostatic design. However, they soon encountered the same difficulties that even present designers face; planar speakers require a very large surface area to reproduce the lower frequencies of the audio spectrum. Because the management at Bell Labs considered large speakers unacceptable, Rice and Kellogg's work on electrostatics would never be put to use for a commercial product. Reluctantly, they advised the Bell management to go with the cone. For the next 30 years, the electrostatic design lay dormant.

During the Great Depression of the 1930's, consumer audio almost died. The new electrically amplified loudspeaker never gained acceptance, as most people continued to use their old Victrola-style acoustic gramophones. Prior to the end of World War II, consumer audio saw little, if any, progress. However, during the late 1940's, audio experienced a great rebirth. Suddenly there was tremendous interest in audio products, and with that, a great demand for improved audio components. No sooner had the cone become established than it was challenged by products developed during this new rebirth.

In 1947, Arthur Janszen, a young Naval engineer, took part in a research project for the Navy. The Navy was interested in developing a better instrument for testing microphone arrays. The test instrument needed an extremely accurate speaker, but Janszen found that the cone speakers of the period were too nonlinear in phase and amplitude response to meet his criteria. Janszen believed that electrostats were inherently more linear than cones, so he built a model using a thin plastic diaphragm treated with a conductive coating. This model confirmed Janszen's beliefs, for it exhibited remarkable phase and amplitude linearity.

Janszen was so excited with the results that he continued research on the electrostatic speaker on his own time. He soon thought of insulating the stators to prevent the destructive effects of arcing. By 1952, he had an electrostatic tweeter element ready for commercial production. This new tweeter soon created a sensation among American audio hobbyists. Since Janszen's tweeter element was limited to high frequency reproduction, it often found itself used in conjunction with woofers—most notably, those from Acoustic Research. These systems were highly regarded by all audio enthusiasts.

As good as these systems were, they would soon be surpassed by another electrostatic speaker.

In 1955, Peter Walker published three articles regarding electrostatic loudspeaker design in *Wireless World*, a British magazine. In these articles, Walker demonstrated the benefits of the electrostatic loudspeaker. He explained that electrostatics permit the use of diaphragms that are low in mass, large in area and uniformly driven over their surfaces by electrostatic forces. Due to these characteristics, electrostats have the inherent ability to produce a wide bandwidth, flat frequency response with distortion products being no greater than the electronics driving them.

By 1956, Walker backed up his articles by introducing a consumer product, the now famous Quad ESL. This speaker immediately set a standard of performance for the audio industry due to its incredible accuracy. However, in actual use, the Quad had a few problems. It could not be played very loud, it had poor bass performance, it presented a difficult load that some amplifiers did not like, its dispersion

was very directional and its power handling was limited to around 70 watts. As a result, many people continued to use box speakers with cones.

In the early 1960's Arthur Janszen joined forces with the KLH loudspeaker company, and together they introduced the KLH 9. Due to the large size of the KLH 9, it did not have as many sonic limitations as the Quad. The KLH 9 could play markedly louder and lower in frequency than the Quad ESL. Thus a rivalry was born.

Janszen continued to develop electrostatic designs. He was instrumental in the design of the Koss Model One, the Acoustech and the Dennesen speakers. Roger West, the chief designer of the Janszen Corporation, became the president of Sound Lab. When Janszen Corporation was sold, the RTR loudspeaker company bought half of the production tooling. This tooling was used to make the electrostatic panels for the Servostatic, a hybrid electrostatic system that was

Infinity's first speaker product. Other companies soon followed; each with their own unique applications of the technology. These include Acoustat, Audiostatic, Beverage, Dayton Wright, Sound Lab and Stax, to name a few.

Electrostatic speakers have progressed and prospered because they actually do what Peter Walker claimed they would. The limitations and problems experienced in the past were not inherent to the electrostatic concept. They were related to the applications of these concepts.

Today, these limitations have been resolved. Advancements in materials due to the U.S. space program give designers the ability to harness the superiority of the electrostatic principle. Today's electrostats use advanced insulation techniques or provide protection circuitry. The poor dispersion properties of early models have been addressed by using delay lines, acoustical lenses, multiple panel arrays or, as in our own products, by curving the diaphragm. Power handling and sensitivity have also been increased.

These developments allow the consumer the opportunity to own the highest performance loudspeaker products ever built. It's too bad Rice and Kellogg were never able to see just how far the technology would be taken.

**These developments allow
the consumer to own the
highest performance loud-
speaker products ever built.**

FREQUENTLY ASKED QUESTIONS

How do I clean my speakers?

Use a dust free cloth or a soft brush to remove the dust from your speakers. We also recommend a specialty cloth (available at the Xstatic shop at www.martinlogan.com) that cleans your speakers better than anything else we have tried. For the wood surfaces it is acceptable to slightly dampen the cloth. **Do not spray any kind of cleaning agent on or in close proximity to the electrostatic element. Avoid the use of ammonia based products or silicone oil on the wood parts.**

What is the advantage of ESL?

Since the diaphragm is uniformly driven over its entire surface—unlike a tweeter that is only driven at its edges— it is the only technology that can be made large enough to play bass, yet is still light enough for high frequencies. This unique property allows for the elimination of high frequency crossover points and their associated distortions.

Could you suggest a list of suitable electronics and cables that would be ideal for MartinLogan speakers?

The area of electronics and cable choice is probably the most common type of question that we receive. It is also the most subjective. We have repeatedly found that brands that work well in one setup will drive someone else nuts in another. We use many brands with great success. Again, we have no favorites; we use electronics and cables quite interchangeably. We would suggest listening to a number of brands—and above all else— trust your ears. Dealers are always the best source for information when purchasing additional audio equipment.

Why does my speaker make popping noises and hums?

The Purity features a built in muting circuit that will detect popping anomalies and minimize them.

When using the speaker level inputs a popping noise may occur when the amplifier is turned on or off. This is caused by grounding interaction between the speaker and the amplifier. It is normal and to be expected.

When making or breaking connections from devices that utilize the Line Level input a popping noise may occur.

This is caused by grounding and static discharge interaction. It is normal and to be expected when using this method of connection. If a cable is connected to the speaker, but is left unterminated at the device end you may also experience a low-level hum. To minimize these intermittent noises we recommend using a device that is permanently connected (such as a digital music player docking station).

Is there likely to be any interaction between my speakers and the television in my Audio/Video system?

Actually, there is less interaction between a television and an electrostatic speaker than between a television and a conventional system. However, we do recommend that you keep your speakers at least one foot away from the television because of the dynamic woofer they employ.

Will my electric bill go 'sky high' by leaving my speakers plugged in all the time?

No. A pair of MartinLogan's will draw about 8 watts maximum (idle). There is circuitry to turn off the static charge when not in use; however, actual consumption will remain close to the same. The primary purpose of the sensing circuitry is to prevent dust collection on the electrostatic element.

If the diaphragm is punctured with a pencil or similar item, how extensive would the damage to the speaker be?

Our research department has literally punctured hundreds of holes in a diaphragm, neither affecting the quality of the sound nor causing the diaphragm to rip. However, you will be able to see the actual puncture and it can be a physical nuisance. If this is the case, replacing the electrostatic transducer will be the only solution.

Will exposure to sunlight affect the life or performance of my speakers?

We recommend that you not place any loudspeaker in direct sunlight. The ultraviolet (UV) rays from the sun can cause deterioration of grill cloth, speaker cones, etc. Small exposures to UV will not cause a problem. In general, the filtering of UV rays through glass will greatly reduce the negative effects on the electrostatic membrane itself.

Will excessive smoke or dust cause any problems with my electrostatic speakers?

Exposure to excessive contaminants such as smoke or dust may potentially affect the performance of the electrostatic membrane, and may cause discoloration of the diaphragm membrane. When not in use for extended periods, you should unplug the speakers and cover them with the plastic bags in which the speakers were originally packed. It is a good idea to vacuum the electrostatic portion of each speaker three or four times a year. See the vacuuming FAQ.

A problem has recently developed with my MartinLogan speakers. The right speaker seems to be hissing even when the amplifier and such are not connected. I was wondering if this sounds like any problem you have encountered previously and have a simple solution for or might it be something which will need to be looked into more carefully.

Your speakers are dusty. See the vacuuming FAQ. The electrostatic charge on the element has attracted airborne dust or pollen. Since 1993, all of our speakers have been built with a charging circuit board that only charges the electrostatic element when music plays. At other times they are not charged and cannot collect dust. You can get the same benefit by simply unplugging them whenever they are not in use. A power strip is an easy way to do that.

Could my children, pets, or myself be shocked by the high-voltage present in the electrostatic panel?

No. High voltage with low current is not dangerous. As a matter of fact, the voltage in our speakers is 10 times less than the static electricity that builds up on the surface of your television screen.

How do MartinLogan speakers hold up over a long term in the humidity of tropical climates?

We should tell you that MartinLogan indeed has a very substantial number of customers in tropical regions of the world. Our speakers have been serving them nicely for many years. This concern may have come from our earlier design of speakers, which were charged continuously. Since 1993, all of our speakers have been designed so that they only charge the panel while music is being played. This improvement has made a tremendous difference in the consistent performance of our product. There may be a little more maintenance involved in humid regions when not in an air conditioned environment. Simply enough, the concern is to keep the electrostatic panels dust free. Humidity will combine with any dust on the panel to make it slightly conductive. This will result in a slight pathway for the charge to leave the membrane of the speaker. The solution is simple. They only require occasional vacuuming with a strong vacuum hose.

How do I vacuum my MartinLogan speakers?

Vacuuming will be most effective if the speakers have been unplugged for six hours to twelve hours (or overnight). You need not worry about the vacuum pressure damaging the "delicate" membrane. It is extraordinarily durable. Dirt and dust may be vacuumed off. Use an open hose with your finger tips at the opening acting as a soft bumper to prevent the hose from scratching the coating of the panel. When vacuuming or blowing off your panels do so to both sides, but focus the majority of your attention on the front of the panels.

Should I unplug my speakers during a thunderstorm?

Yes, or before. It's a good idea to disconnect all of your audio/video components during stormy weather.

No Output

- Check that all your system components are turned on.
- Check your speaker wires and connections.
- Check all interconnecting cables.
- Try hooking up a different set of speakers. The lack of output could point to a problem with other equipment in your system (amp, pre-amp, processor, etc.)

Weak or no Output from Electrostatic Panel, Loss of Highs

- Check the power cord. Is it properly connected to the speaker and to the wall?
- Is the power cord connected to a switched outlet?
- Dirt and dust may need to be vacuumed off. Please see the FAQ regarding vacuuming.
- Check the binding posts. Are the dirty? If so clean them with rubbing alcohol.
- Check the binding posts. Are the loose? Make sure they are firmly hand-tightened.
- Has a foreign substance (such as a household cleaning chemical or soap) been applied to the panel? If so the speaker will require servicing.

Popping and Ticking Sounds, Funny Noises

- These occasional noises are harmless and will not hurt your audio system or your speakers. All electrostatic speakers are guilty of making odd noises at one time or another. It is the result of airborne contaminants (most notably dust). Vacuuming is recommended.
- These noises may be caused by dirt and dust particles collecting on the speaker, by high humidity.
- Dirt and dust may need to be vacuumed off. Please see the FAQ regarding vacuuming.

Exaggerated Highs, Brightness

- Check the toe-in of the speakers. Read the Placement section of this manual for more information.

Muddy Bass

- Check placement. Try moving the speakers closer to the front and sidewalls.
- Possibly means low electrostatic panel output. See 'Weak Output from Electrostatic Panel, Loss of Highs'.

Lack of Bass, No Bass

- Check your speaker wires. Is the polarity correct?
- Check the binding posts. Are the dirty? If so clean them with rubbing alcohol.
- Check the binding posts. Are the loose? Make sure they are firmly hand-tightened.

Poor Imaging

- Check placement. Are both speakers the same distance from the walls? Do they have the same amount of toe-in? Try moving the speakers away from the back and sidewalls.
- Check the polarity of the speaker wires. Are they connected properly?
- Try switching the left speaker with the right.
- Are your speakers set up in an L-shaped room? If so, you may experience off-center imaging. Talk to your dealer about acoustical room treatment options.

GENERAL INFORMATION

Specifications*

System Frequency Response:

41–23,000 Hz \pm 3db

Dispersion

Horizontal: 30 Degrees

Vertical: 28" (71 cm) Line Source

Sensitivity

93 dB/2.83 volts/meter (binding posts)

95 dB/0.1 volts/meter (line level input)

Impedance

2,000 Ohms (binding posts)

14,000 Ohms (line level input)

Crossover Frequency

450 Hz

Components

Custom-wound audio transformer, air core coils, high-efficiency, high-resolution amplifier

Bass Level Control

+3dB, flat, -3dB

Woofers Type

Two 6.5" (16.5 cm) high excursion, aluminum cone with extended throw driver assembly, non-resonance asymmetrical chamber format, bass reflex

Internal Amplifier

200 watts

Recommended Amplifier Power

50–200 watts

AC Mains Power Draw

Maximum Current Draw: 3 amps

Maximum Power: 250 watts

Standby Power: 10 watts

Weight

51 lbs. each (23.2 kg)

Size

52.3" h x 9.7" w x 14.7" d

(132.9 h x 24.5 w x 37.3 d cm)

Warranty and Registration

Your Purity speakers are provided with an automatic Limited 90 Day Warranty coverage. You have the option, at no additional charge, to receive a Limited 5 Year Warranty coverage. To obtain the Limited 5 Year Warranty coverage you need to complete and return the Certificate of Registration, included with your speakers, and provide a copy of your dealer receipt, to MartinLogan within 30 days of purchase. For your convenience MartinLogan also offers online warranty registration at www.martinlogan.com.

MartinLogan may not honor warranty service claims unless we have a completed Warranty Registration card on file! If you did not receive a Certificate of Registration with your new Purity speakers you cannot be sure of having received new units. If this is the case, please contact your authorized MartinLogan dealer.

Serial Number

Purity's serial number is located near the binding posts. Each individual unit has a unique serial number.

Service

Should you be using your MartinLogan product in a country other than the one in which it was originally purchased, we ask that you note the following:

- 1 The appointed MartinLogan distributor for any given country is responsible for warranty servicing only on units distributed by or through it in that country in accordance with its applicable warranty.
- 2 Should a MartinLogan product require servicing in a country other than the one in which it was originally purchased, the end user may seek to have repairs performed by the nearest MartinLogan distributor, subject to that distributor's local servicing policies, but all cost of repairs (parts, labor, transportation) must be born by the owner of the MartinLogan product.
- 3 If, after owning your speakers for six months, you relocate to a country other than the one in which you purchased your speakers, your warranty may be transferable. Contact MartinLogan for details.

**Specifications are subject to change without notice.*

DIMENSIONAL DRAWINGS

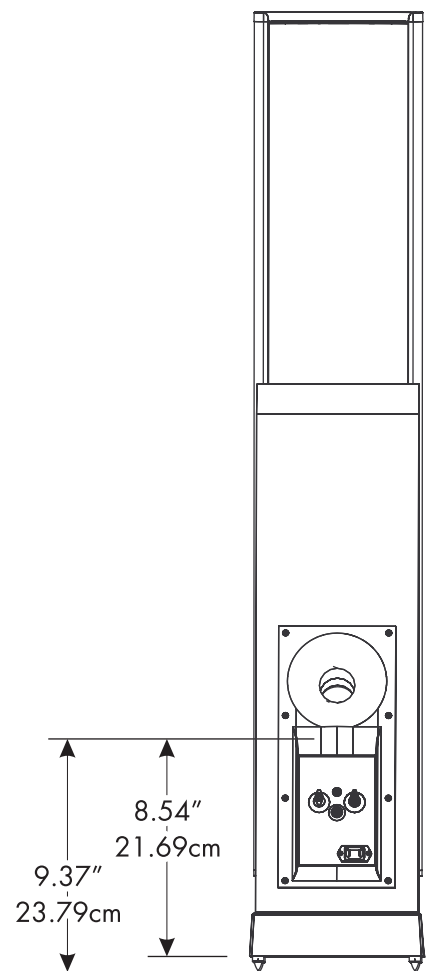
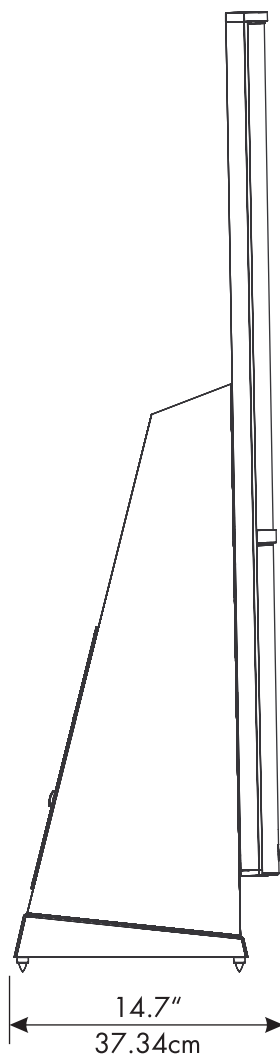
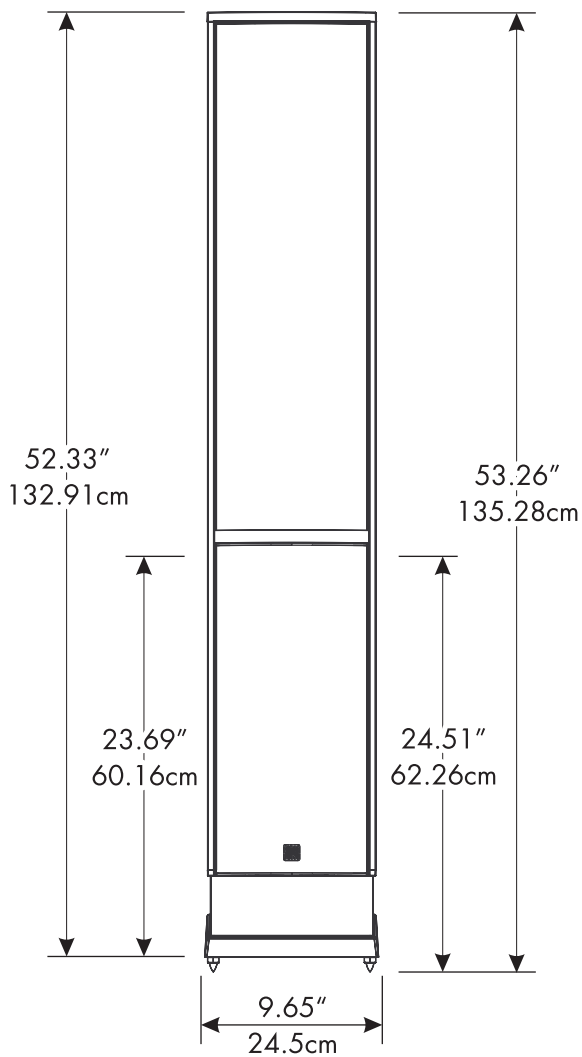
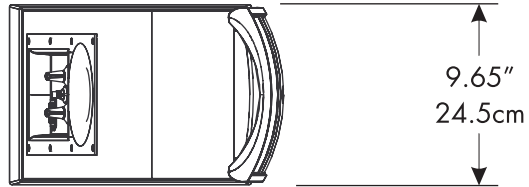

GLOSSARY OF AUDIO TERMS

AC. Abbreviation for alternating current.

Active crossover. Uses active devices (transistors, IC's, tubes) and some form of power supply to operate.

Amplitude. The extreme range of a signal. Usually measured from the average to the extreme.

Arc. The visible sparks generated by an electrical discharge.

Bass. The lowest frequencies of sound.

Bi-Amplification. Uses an electronic crossover, or line-level passive crossover, and separate power amplifiers for the high and low frequency loudspeaker drivers.

Capacitance. That property of a capacitor which determines how much charge can be stored in it for a given potential difference between its terminals, measured in farads, by the ratio of the charge stored to the potential difference.

Capacitor. A device consisting of two or more conducting plates separated from one another by an insulating material and used for storing an electrical charge. Sometimes called a condenser.

Clipping. Distortion of a signal by its being chopped off. An overload problem caused by pushing an amplifier beyond its capabilities. The flat-topped signal has high levels of harmonic distortion which creates heat in a loudspeaker and is the major cause of loudspeaker component failure.

CLS. The abbreviation for curvilinear linesource.

Crossover. An electrical circuit that divides a full bandwidth signal into the desired frequency bands for the loudspeaker components.

dB (decibel). A numerical expression of the relative loudness of a sound. The difference in decibels between two sounds is ten times the Base 10 logarithm of the ratio of their power levels.

DC. Abbreviation for direct current.

Diffraction. The breaking up of a sound wave caused by some type of mechanical interference such as a cabinet edge, grill frame or other similar object.

Diaphragm. A thin flexible membrane or cone that vibrates in response to electrical signals to produce sound waves.

Distortion. Usually referred to in terms of total harmonic distortion (THD) which is the percentage of unwanted harmonics of the drive signal present with the wanted signal. Generally used to mean any unwanted change introduced by the device under question.

Driver. See transducer.

Dynamic Range. The range between the quietest and the loudest sounds a device can handle (often quoted in dB).

Efficiency. The acoustic power delivered for a given electrical input. Often expressed as decibels/watt/meter (dB/w/m).

ESL. The abbreviation for electrostatic loudspeaker.

Headroom. The difference, in decibels, between the peak and RMS levels in program material.

Hybrid. A product created by the marriage of two different technologies. Meant here as the combination of a dynamic woofer with an electrostatic transducer.

Hz (Hertz). Unit of frequency equivalent to the number of cycles per second.

Imaging. To make a representation or imitation of the original sonic event.

Impedance. The total opposition offered by an electric circuit to the flow of an alternating current of a single frequency. It is a combination of resistance and reactance and is measured in ohms. Remember that a speaker's impedance changes with frequency, it is not a constant value.

Inductance. The property of an electrical circuit by which a varying current in it produces a varying magnetic field that introduces voltages in the same circuit or in a nearby circuit. It is measured in henrys.

Inductor. A device designed primarily to introduce inductance into an electrical circuit. Sometimes called a choke or coil.

Linearity. The extent to which any signal handling process is accomplished without amplitude distortion.

Midrange. The middle frequencies where the ear is the most sensitive.

Passive crossover. Uses no active components (transistors, IC's, tubes) and needs no power supply (AC, DC, battery) to operate. The crossover in a typical loudspeaker is of the passive variety. Passive crossovers consist of capacitors, inductors and resistors.

Phase. The amount by which one sine wave leads or lags a second wave of the same frequency. The difference is described by the term phase angle. Sine waves in phase reinforce each other; those out of phase cancel.

Pink noise. A random noise used in measurements, as it has the same amount of energy in each octave.

Polarity. The condition of being positive or negative with respect to some reference point or object.

RMS. Abbreviation for root mean square. The effective value of a given waveform is its RMS value. Acoustic power is proportional to the square of the RMS sound pressure.

Resistance. That property of a conductor by which it opposes the flow of electric current, resulting in the generation of heat in the conducting material, usually expressed in ohms.

Resistor. A device used in a circuit to provide resistance.

Resonance. The effect produced when the natural vibration frequency of a body is greatly amplified by reinforcing vibrations at the same or nearly the same frequency from another body.

Sensitivity. The volume of sound delivered for a given electrical input.

Stator. The fixed part forming the reference for the moving diaphragm in a planar speaker.

THD. The abbreviation for total harmonic distortion. (See Distortion)

TIM. The abbreviation for transient intermodulation distortion.

Transducer. Any of various devices that transmit energy from one system to another, sometimes one that converts the energy in form. Loudspeaker transducers convert electrical energy into mechanical motion.

Transient. Applies to that which lasts or stays but a short time. A change from one steady-state condition to another.

Tweeter. A small drive unit designed to reproduce only high frequencies.

Wavelength. The distance measured in the direction of progression of a wave, from any given point characterized by the same phase.

White noise. A random noise used in measurements, as it has the same amount of energy at each frequency.

Woofers. A drive unit operating in the bass frequencies only. Drive units in two-way systems are not true woofers but are more accurately described as being mid/bass drivers.

NOTES



WARNING! Do not use your Purity loudspeakers outside of the country of original sale—voltage requirements vary by country. Improper voltage can cause damage that will be potentially expensive to repair. The Purity is shipped to authorized MartinLogan distributors with the correct power supply for use in the country of intended sale. A list of authorized distributors can be accessed at www.martinlogan.com or by emailing info@martinlogan.com.



Lawrence, Kansas, USA tel 785.749.0133 fax 785.749.5320 www.martinlogan.com